

# MultiCOM 401

- Profibus DP Gateway -



USER MANUAL



---

## **INTRODUCTION**

Thank you for choosing our product.

The accessories described in this manual are of the highest quality, carefully designed and built in order to ensure excellent performance.

This manual contains detailed instructions on how to install and use the product.

**It should be kept with care near the *MultiCOM 401*, so that it can be consulted for information on how to use and make the most of your device. IT SHOULD BE READ BEFORE YOU START WORKING ON THE DEVICE.**

---

## **SAFETY**

**This part of the manual contains SAFETY precautions that must be followed scrupulously.**

- ❖ The device has been designed for professional use and is therefore not suitable for use in the home.
- ❖ The device has been designed to operate only in closed environments. It should be installed in rooms where there are no inflammable liquids, gas or other harmful substances.
- ❖ Take care that no water or liquids and/or foreign bodies fall into the device.
- ❖ In the event of a fault and/or impaired operation of the device, do not attempt to repair it but contact the authorized service centre.
- ❖ The device must be used exclusively for the purpose for which it was designed. Any other use is to be considered improper and as such dangerous. The manufacturer declines all responsibility for damage caused by improper, wrong and unreasonable use.

© No part of this manual may be reproduced without the prior written permission of the manufacturer. The manufacturer reserves the right to modify the product described in this manual at any time and without notice.

---

# SUMMARY

<b>PRESENTATION</b>	<b>5</b>
<i>DESCRIPTION</i>	5
<i>OPENING THE PACKAGING AND CHECKING THE CONTENTS</i>	6
<b>INSTALLATION AND CONFIGURATION</b>	<b>7</b>
<i>ADDRESS CONFIGURATION</i>	7
<i>BUS TERMINATION AND BIASING</i>	8
<i>JUMPER SETTINGS</i>	9
<i>CONNECTION TO THE UPS</i>	9
<b>PROFIDRIVE MODE</b>	<b>10</b>
<i>CYCLIC COMMUNICATION (PROCESS DATA)</i>	10
<i>PKW-PART</i>	11
<i>PZD-PART</i>	14
<i>USER DEFINED PZD SLOTS</i>	14
<i>PERMANENT PZD CONFIGURATION</i>	15
<b>LIST OF PARAMETERS</b>	<b>16</b>
<i>UPS PARAMETERS</i>	16
<i>GATEWAY INTERNAL PARAMETERS</i>	19
<i>PROFIDRIVE STANDARD PARAMETERS</i>	19
<b>CONNECTORS PINOUT</b>	<b>21</b>
<b>DIAGNOSTIC LED</b>	<b>22</b>

---

# PRESENTATION

## DESCRIPTION

**MultiCOM 401** allows you to connect the UPS to a Profibus DP network. The device enables to integrate, in industrial environment, the management and monitoring of the UPS into a control system based on one of the most popular field bus designed especially for communication between automation control systems and distributed I/O. Baud rates from 9.6 kbit/s up to 12 Mbit/s are supported and automatically detected.

The device also offers an RS-232 serial line through which the UPS can be monitored using the GPSEER protocol (PRTK code: GPSEER11201...).

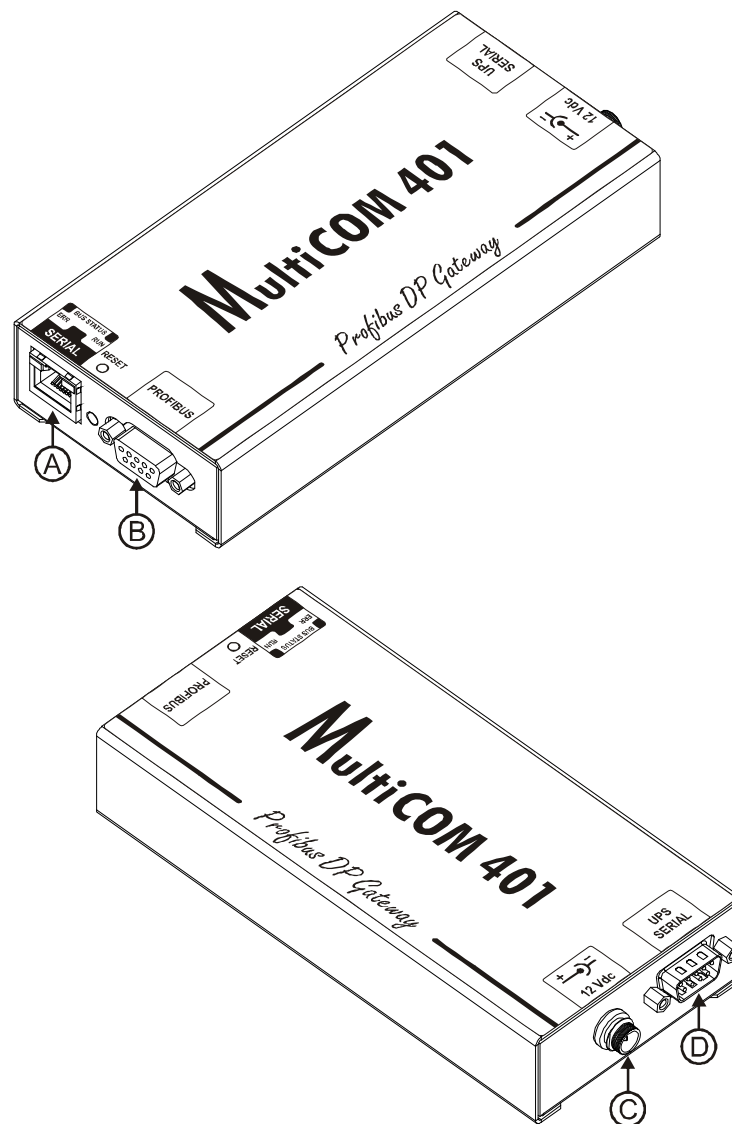

- A: RS-232 communication port
- B: PROFIBUS connector
- C: power supply connector
- D: connector for connection to the UPS

## **OPENING THE PACKAGING AND CHECKING THE CONTENTS**

After opening the packaging, first check the contents.  
The packaging should contain:

### ***MultiCOM 401***

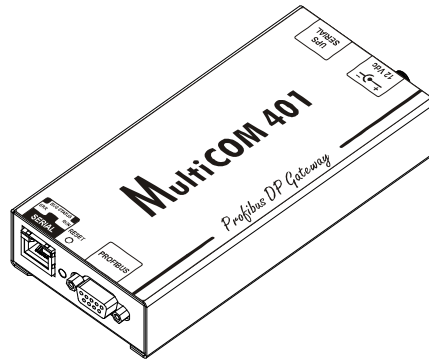

12Vdc 0.5A external power supply unit

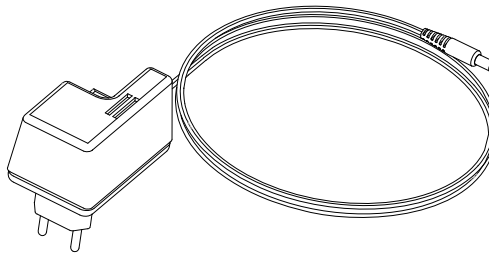

DB9-RJ45 serial cable

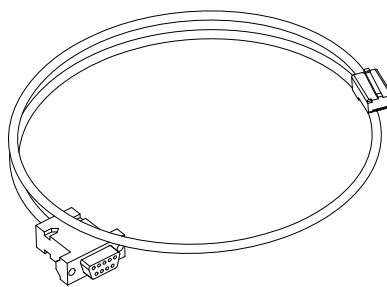

CD-Rom (User manual and GSD file)

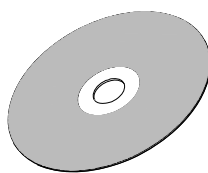

---

# INSTALLATION AND CONFIGURATION



In order to access the DIP-switches and the jumpers, disconnect the device from the power supply, remove the 4 screws on the base and then remove the cover

## ADDRESS CONFIGURATION

The Profibus address must be configured using the SW1 and SW2 rotary switch (shown in the figure). Allowable addresses are 1÷99.

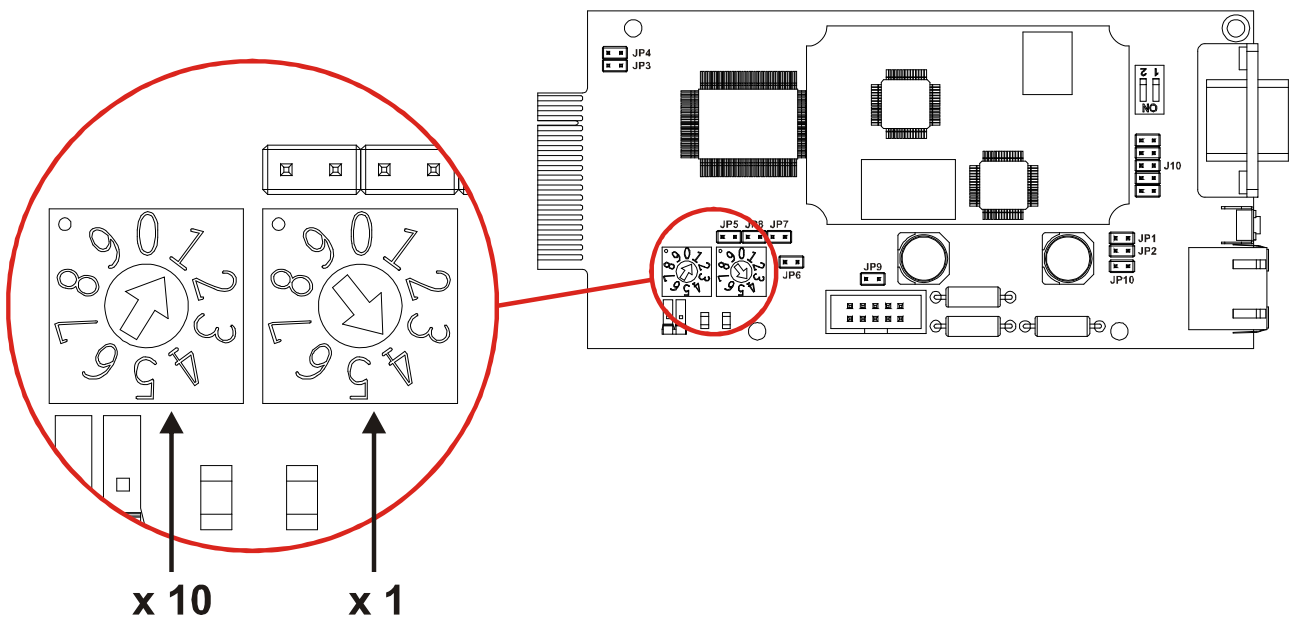

## BUS TERMINATION AND BIASING

**MultiCOM 401** is supplied with the bus termination and biasing resistors already mounted internally ( $R=100\Omega$ ). Dip-switch SW3 must be closed in order to insert these resistors (see figure).

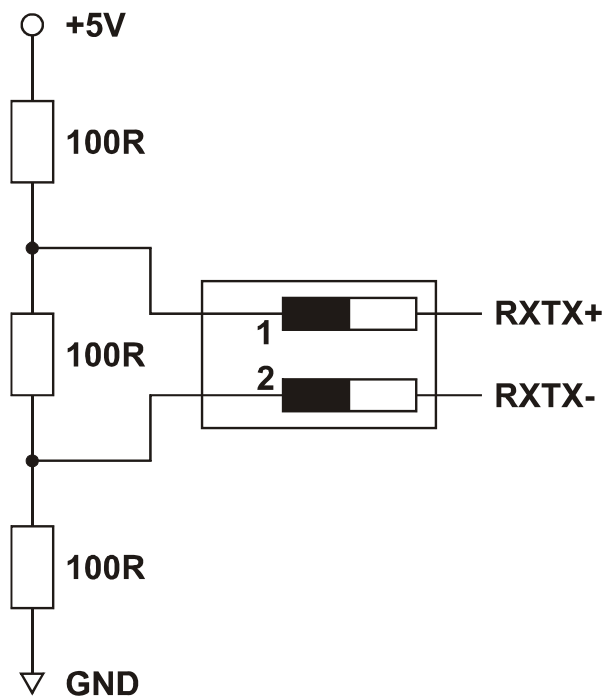
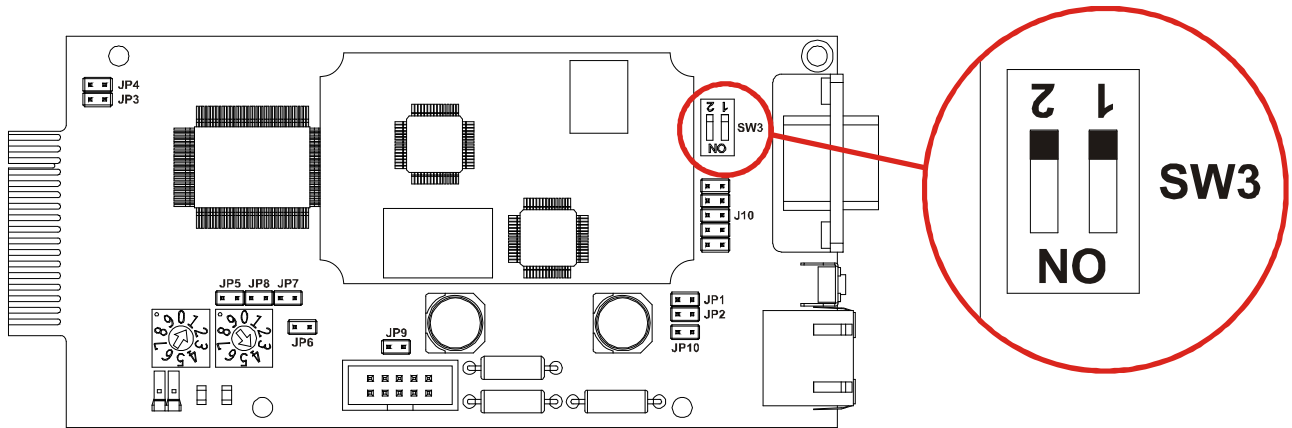



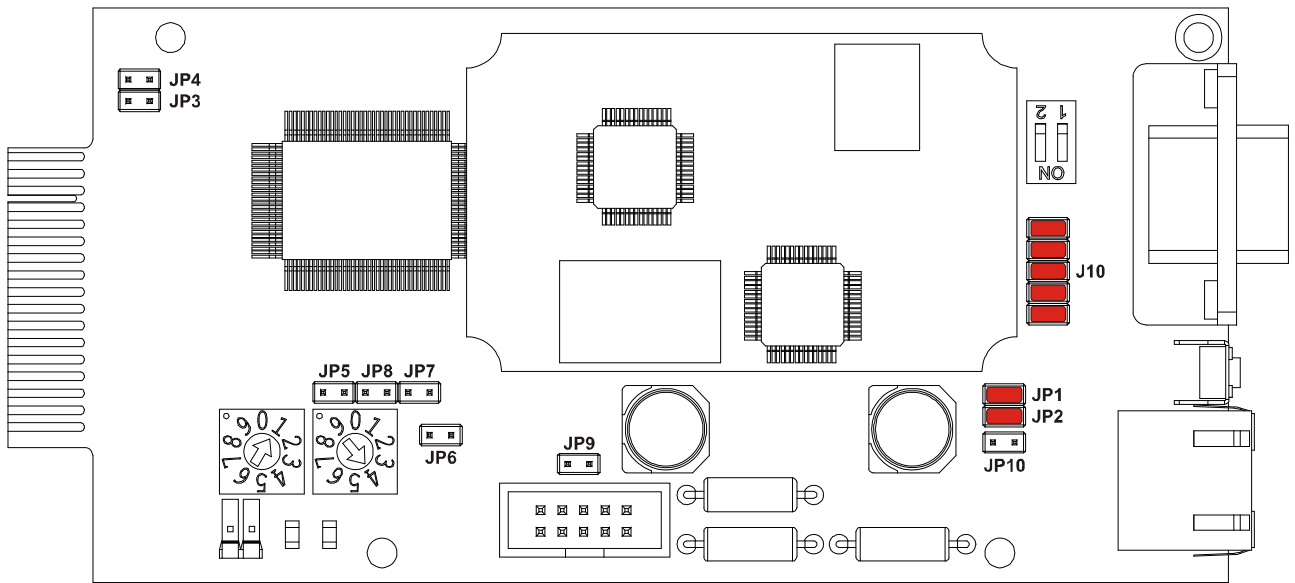

## JUMPER SETTINGS

For proper working of the device, the jumper have to be set as shown in the figure below.



 = closed

 = open

## CONNECTION TO THE UPS

Connect the “UPS SERIAL” port of the device to the serial port of the UPS using the cable supplied with the UPS.

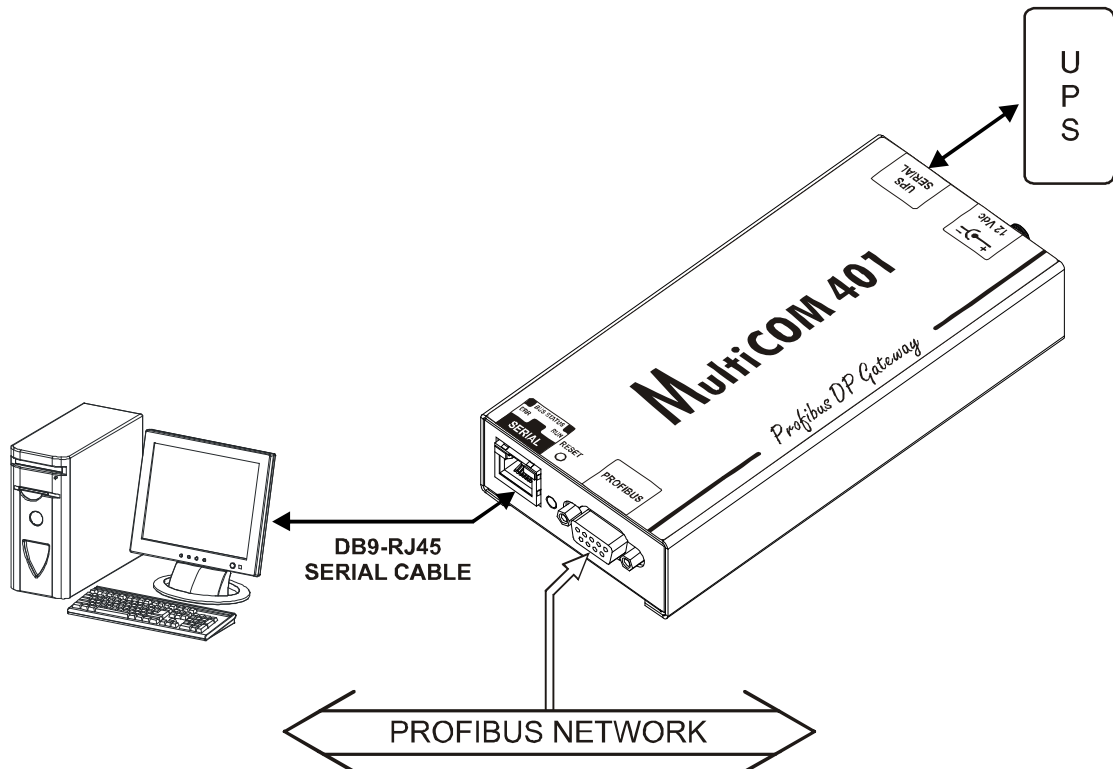

## PROFIDRIVE MODE

The application can be driven in ProfiDrive standard compatible mode (ProfiDrive Mode). Driving mode is selected by using the appropriate GSD file: **RPS\_0B74.gsd**.

The gateway will accept all the configurations specified by Profidrive V2 (PPO1-PPO5).

Using the ProfiDrive mode the standard ProfiDrive procedures can be used and it is possible to access to all application parameters in two possible ways:

1. Parameter area PKW: allow random access to any register in the range (1 – 799);
2. Process data area PZD: access automatically a predefined and configurable set of parameters.

### CYCLIC COMMUNICATION (PROCESS DATA)

Cyclic communication data are exchanged with the Profibus DP master at every communication cycle. The exchanged data format and length are specified at the initialization by Profibus DP master using the Profibus DP configuration mechanism.

The supported configuration are:

Type	Configuration bytes	Process data layout
Profidrive V2, PPO1	0xf3 0xf1	PKW + 2 words PZD
Profidrive V2, PPO2	0xf3 0xf5	PKW + 6 words PZD
Profidrive V2, PPO3	0xf1	2 words PZD
Profidrive V2, PPO4	0xf5	6 words PZD
Profidrive V2, PPO5	0xf3 0xf9	PKW + 10 words PZD

The cyclic data consists of two parts, a parameter area (PKW) and a process data area (PZD). The layout of the process data is:

PKW – 4 words			PZD - 2÷10 words									
PKE	IND	PWE	PZD 1	PZD 2	PZD 3	PZD 4	PZD 5	PZD 6	PZD 7	PZD 8	PZD 9	PZD 10

PPO1				
PKE	IND	PWE	PZD 1	PZD 2

PPO2								
PKE	IND	PWE	PZD 1	PZD 2	PZD 3	PZD 4	PZD 5	PZD 6

PPO3				
			PZD 1	PZD 2

PPO4								
			PZD 1	PZD 2	PZD 3	PZD 4	PZD 5	PZD 6

PPO5												
PKE	IND	PWE	PZD 1	PZD 2	PZD 3	PZD 4	PZD 5	PZD 6	PZD 7	PZD 8	PZD 9	PZD 10

The PKW part of the process data is used for asynchronous parameter access over process data. The PZD words can be programmed to hold a value of any available parameter of the word type.

## PKW-PART

The parameter part (PKW) is fixed to 4 words and can be used for reading and/or updating the parameters in the application one by one. Requests and responses use the predefined handshake procedure.

The PKW is further divided into three parts:

1. PKE: Parameter ID (2 bytes);
2. IND: Sub-index (2 bytes), 2nd byte isn't used and should be set to 0;
3. PWE: Parameter value (4 bytes).

PKW			
PKE Parameter ID	IND Sub-index	PWE Parameter value	
Word 0	Word 1	Word 2	Word 3
b15 ..... b0	b15 ..... b0	b15 ..... b0	b15 ..... b0

PKE consists of three parts:

1. AKA: command/response identifier (4 bits);
2. SPM: toggle bit, not used (1 bit);
3. PNU: parameter number (11 bits).

PKE															
b15	b14	b13	b12	b11	b10	b9	b8	b7	b6	b5	b4	b3	b2	b1	b0
AKA				SPM	PNU										

PNU parameters:

- 1÷799 are UPS PARAMETERS;
- 800÷899 are GATEWAY INTERNAL PARAMETERS;
- 900÷999 are PROFIDRIVE STANDARD PARAMETERS.

AKA field meanings (master → slave)				
Value	Function	Ack+	Ack-	Note
0	No request	0	-	
1	Request parameter value	1	7	
2	Change parameter value (word)	1	7/8	
3	Change parameter value (long word)	2	7/8	
4	Request description element	3	7	not used
5	Change description element	3	7	not used
6	Request parameter value (array)	4	7	
7	Change parameter value (array word)	4	7/8	
8	Change parameter value (array long word)*	5	7/8	not used
9	Request number of array elements	6	7	

### AKA field meanings (slave → master)

Value	Function
0	No response
1	Transfer parameter value (word)
2	Transfer parameter value (long word)
3	Transfer description element*
4	Transfer parameter value (array word)
5	Transfer parameter value (array long word)*
6	Request number of array elements
7	Request rejected, followed by fault code (in PWE part). Error values: 0 = Non-admissible parameter number 1 = Parameter value cannot be changed 2 = Upper or lower limit exceeded 3 = Erroneous sub-index 4 = No array 5 = Incorrect data type 7 = Descriptive element cannot be changed 9 = Descriptive data not available 11 = No parameter change rights 17 = Task cannot be executed due to operating status 22 = Parameter address impermissible 24 = Number of values not consistent 101 = communication error to the application
8	No parameter change rights by PKW interface

## EXAMPLES



In the following examples, when you see:  
**Index** → you have to refer to *LIST OF PARAMETERS* chapter;  
**xxxx** → don't care about the word's value.

### Read word parameter (AKA=1):

	Word 0	Word 1	Word 2	Word 3
Output:	<b>0x1000 + Index</b>	xxxx	xxxx	xxxx
Input:	xxxx	xxxx	xxxx	<b>Value</b>

Read *Input mains voltage V1* (Index 12 [0x000C] UPS PARAMETER):

Output:	0x100C	xxxx	xxxx	xxxx
---------	--------	------	------	------

Read *Output nominal power* (Index 80 [0x0050] UPS PARAMETER):

Output:	0x1050	xxxx	xxxx	xxxx
---------	--------	------	------	------

### Write word parameter (AKA=2):

	Word 0	Word 1	Word 2	Word 3
Output:	<b>0x2000 + Index</b>	xxxx	xxxx	<b>Value</b>
Input:	xxxx	xxxx	xxxx	xxxx

Write code 20 [0x0014] in *Command code* register (Index 113 [0x0071] UPS PARAMETER), in order to execute a battery test:

Output:	0x2071	xxxx	xxxx	0x0014
---------	--------	------	------	--------

For further examples about this function, see *PERMANENT PZD CONFIGURATION*.

### Read array.word parameter (AKA=6):

	Word 0	Word 1	Word 2	Word 3
Output:	<b>0x6000 + Index</b>	<b>YY00</b> YY is sub-index of array	xxxx	xxxx
Input:	xxxx	xxxx	xxxx	<b>Value</b>

### Write array.word parameter (AKA=7):

	Word 0	Word 1	Word 2	Word 3
Output:	<b>0x7000 + Index</b>	<b>YY00</b> YY is sub-index of array	xxxx	<b>Value</b>
Input:	xxxx	xxxx	xxxx	xxxx

For further examples about this function, see *USER DEFINED PZD SLOTS*.

## PZD-PART

MultiCOM 401 is provided with a default PZD input configuration:

DEFAULT PZD INPUT CONFIGURATION				
	DESCRIPTION	Unit	Index	
PZD1	UPS states (see the STATES table)	Flag	1	0x0001
PZD2	UPS states (see the STATES table)	Flag	2	0x0002
PZD3	Input mains voltage V1	V	12	0x000C
PZD4	Input mains voltage V2	V	13	0x000D
PZD5	Input mains voltage V3	V	14	0x000E
PZD6	Load phase L1	%	38	0x0026
PZD7	Load phase L2	%	39	0x0027
PZD8	Load phase L3	%	40	0x0028
PZD9	Remaining back-up time	Minutes	54	0x0036
PZD10	Remaining Battery Capacity	%	52	0x0034

In order to have different UPS parameters in PZD-part, the default configuration can be changed by user as described below.

## USER DEFINED PZD SLOTS

For configurations the standard parameters 915 and 916 are used to define which values are transferred in these slots.

Parameter 915 defines output and 916 input direction. Both parameters 915 and 916 are of array type and the subindex is used to reference the PZD slot (subindex 1 references PZD slot 1, subindex 2 references PZD slot 2, ... subindex 10 references PZD slot 10). Parameters of type word and byte can be selected (there is an implicit conversion byte-word). Not used PZD slots are marked with 0 in the parameters 915 and 916.

## EXAMPLES

Set input PZD3 with Input mains voltage V1 (index 12 [0x000C] UPS PARAMETER):

PKW	Word 0	Word 1	Word 2	Word 3
Output:	0x7394	0x0300	xxxx	0x000C
Input:	xxxx	xxxx	xxxx	xxxx

Word 0 → Index used 0x394 (916dec)

Word 1 → sub-index YY=03 (PZD3)

Word 3 → Value = index of Input mains voltage V1 in UPS PARAMETER table

Set input PZD10 with Battery voltage (index 48 [0x0030] UPS PARAMETER):

	Word 0	Word 1	Word 2	Word 3
Output:	0x7394	0x0A00	xxxx	0x0030
Input:	xxxx	xxxx	xxxx	xxxx

Word 0 → Index used 0x394 (916dec)

Word 1 → sub-index YY=0A (PZD3)

Word 3 → Value = index of Battery voltage in UPS PARAMETER table

## PERMANENT PZD CONFIGURATION

PZD configuration can be stored to non-volatile memory and automatically restored at the gateway power up. For this purpose the internal gateway parameter 802 is provided. By writing to this parameter the permanent storage of the PZD configuration is controlled. The possible values to be written to this parameter are:

- 0 → none
- 1 → clear non-volatile PZD setting
- 2 → store the current PZD setting to non-volatile memory
- 3 → restore the PZD settings from non-volatile memory

The PZD setting saving is executed on the transition of the value of the parameter 802. To generate this transition firstly store 0 to this parameter and then the desired value.

Once there are stored PZD settings in non-volatile memory, the function 3 (restore) is automatically executed at the gateway power up. In order to stop this auto-initialization the value 1 has to be written to parameter 802.

### EXAMPLES

#### Store PZD setting to non-volatile memory:

	Word 0	Word 1	Word 2	Word 3
Output:	0x2322	xxxx	xxxx	0x0002 Must be 0 before. So write 2 and after 0

Word 0 → Index used 0x322 (802dec)

Word 3 → Value = 2 (store the current PZD setting to non-volatile memory)

#### Reset PZD setting to non-volatile memory:

	Word 0	Word 1	Word 2	Word 3
Output:	0x2322	xxxx	xxxx	0x0001 Must be 0 before. So write 1 and after 0

Word 0 → Index used 0x322 (802dec)

Word 3 → Value = 1 (clear non-volatile PZD setting)

## LIST OF PARAMETERS

Parameters can be divided into three categories:

1. UPS parameters (from the range 1-799)
2. Gateway internal parameters (from the range 800-899)
3. Profidrive standard parameters (from the range 900-999)

### UPS PARAMETERS

Index	Bit	STATES	UNIT
1	0		
	1	Test in progress	Flag
	2		
	3	Shutdown active	Flag
	4	Replace battery	Flag
	5	Battery charged	Flag
	6	Battery charging	Flag
	7	Bypass bad	Flag
	8	UPS communication lost	Flag
	9		
	10		
	11	On bypass	Flag
	12	Battery low	Flag
	13	Battery working	Flag
	14	UPS locked	Flag
15	Output powered	Flag	
2	0÷11		
	12	Input Mains present	Flag
	13	Alarm temperature	Flag
	14	Alarm overload	Flag
	15	UPS failure	Flag



Index	Data type	MEASUREMENTS	UNIT
1	Unsigned16	UPS states (see the STATES table)	Flag
2	Unsigned16	UPS states (see the STATES table)	Flag
3÷11			
12	Unsigned16	<b>Input</b> mains star voltage V1	V
13	Unsigned16	Input mains star voltage V2	V
14	Unsigned16	Input mains star voltage V3	V
15	Unsigned16	Input current phase L1	0.1*A
16	Unsigned16	Input current phase L2	0.1*A
17	Unsigned16	Input current phase L3	0.1*A
18	Unsigned16	Input frequency	0.1*Hz
19÷21			
22	Unsigned16	<b>Bypass</b> mains star voltage V1	V
23	Unsigned16	Bypass mains star voltage V2	V
24	Unsigned16	Bypass mains star voltage V3	V
25	Unsigned16	Bypass frequency	0.1*Hz
26	Unsigned16	<b>Output</b> star voltage V1	V
27	Unsigned16	Output star voltage V2	V
28	Unsigned16	Output star voltage V3	V
29÷31			
32	Unsigned16	Output current phase L1	0.1*A
33	Unsigned16	Output current phase L2	0.1*A
34	Unsigned16	Output current phase L3	0.1*A
35	Unsigned16	Output peak current phase L1	0.1*A
36	Unsigned16	Output peak current phase L2	0.1*A
37	Unsigned16	Output peak current phase L3	0.1*A
38	Unsigned16	Load phase L1	%
39	Unsigned16	Load phase L2	%
40	Unsigned16	Load phase L3	%
41÷43			
44	Unsigned16	Output frequency	0.1*Hz
45÷47			
48	Unsigned16	<b>Battery</b> voltage	0.1*V
49÷50			
51	Unsigned16	Battery current	0.1*A
52	Unsigned16	Remaining Battery Capacity	%
53			
54	Unsigned16	Remaining back-up time	Minutes
55÷61			
62	Unsigned16	Internal UPS <b>temperature</b>	°C
63	Unsigned16	Sensor 1 temperature	°C
64	Unsigned16	Sensor 2 temperature	°C
65÷72			

Index	Data type	NOMINAL DATA	UNIT
73÷77			
78	Unsigned16	Output nominal voltage (star)	V
79	Unsigned16	Output nominal frequency	0.1*Hz
80	Unsigned16	Output nominal power	100*VA
81÷83			
84	Unsigned16	Battery nominal capacity (battery expansion included)	Ah
85	Unsigned16	Battery benches	(1 or 2)
86	Unsigned16	Battery type	Integer
87÷112			

Index	Data type	COMMANDS	UNIT
113	Unsigned16	Command code <sup>(1)</sup>	Integer
114	Unsigned16	Shutdown delay time	Seconds
115	Unsigned16	Restore delay time	Minutes
116	Unsigned16		
117	Unsigned16	Command result <sup>(2)</sup>	Integer
118÷120	Unsigned16		

<sup>(1)</sup> Refer to *Command codes* paragraph

<sup>(2)</sup> Command result = Command code if command is handled from the UPS  
 Command result = Command code + 100 if command is NOT handled from the UPS  
 Command result = 0 if Command code is wrong

Index	Data type	SPECIAL FLAGS (SENTR UPS) <sup>(3)</sup>	UNIT
121	Unsigned16	Byte 1 of "s = xx.." code / Byte 2 of "s = ..xx" code	Flag
122	Unsigned16	Byte 1 of "c = xx.." code / Byte 2 of "c = ..xx" code	Flag
123	Unsigned16	Byte 1 of "b = xx.." code / Byte 2 of "b = ..xx" code	Flag
124	Unsigned16	Byte 1 of "r = xx-.." code / Byte 2 of "r = ..xx-.." code	Flag
125	Unsigned16	Byte 3 of "r = ....-xx" code / Byte 1 of "i = xx-.." code	Flag
126	Unsigned16	Byte 2 of "i = ..xx-.." code / Byte 3 of "i = ....-xx" code	Flag
127	Unsigned16	Byte 1 of "a = xx-...." code / Byte 2 of "a = ..xx-...." code	Flag
128	Unsigned16	Byte 3 of "a = ....-xx.." code / Byte 4 of "a = ....-..xx" code	Flag

<sup>(3)</sup> In order to decode these registers, please refer to the UPS manual

CODE	COMMAND
1 (0x0001)	Command shutdown
2 (0x0002)	Command shutdown and restore
3 (0x0003)	Cancel command codes 1, 2, 12
12 (0x000C)	UPS on bypass
20 (0x0014)	Battery test
22 (0x0016)	Test panel

## **GATEWAY INTERNAL PARAMETERS**

These parameters are used in the ProfiDrive mode

<b>Index</b>	<b>Data type</b>	<b>R/W access</b>	<b>Description</b>
802	Unsigned8	Read-write	Saving PZD setting to the gateway seeprom: 0 - nothing 1 - clear non-volatile PZD setting 2 - store the current PZD setting to non-volatile memory 3 - restore the PZD settings from non-volatile memory

These parameters are used to identify the gateway application type and application version.

<b>Index</b>	<b>Data type</b>	<b>R/W access</b>	<b>Description</b>
800	Unsigned16	Read-write	Gateway application type
801	Unsigned16	Read only	Gateway application version High byte - version Low byte - subversion

## **PROFIDRIVE STANDARD PARAMETERS**

These parameters are defined by profibus standard. They are used in ProfiDrive mode.

<b>Index</b>	<b>Data type</b>	<b>Description</b>
915 [8]	Unsigned16 (Array)	PZD configuring, setpoint telegram Parameter is an array of 8 subindexes for defining output PZD slot content (0=PZD0; 1=PZD1,... 10=PZD10).
916 [8]	Unsigned16 (Array)	PZD configuring, actual value telegram Parameter is an array of 8 subindexes for defining input PZD slot content (0=PZD0; 1=PZD1,... 10=PZD10).
918	Unsigned8	Gateway DP address
922	Unsigned16	Telegram selection Value is 0 (telegram defined by 915,916 parameters)
964 [5]	Unsigned16 (Array)	Device identification Array parameter with the following subindices meanings: Manufacturer code, device type, version, year, day+month
965	Unsigned16	Profile version and subversion (first and second byte)
971	Unsigned16	Saving parameters to the flash A change from 0 to 1 in this parameter value causes saving application parameter to flash (so actually two writings to 971 are needed for the request to save all parameters to flash). NOTE: Currently this parameter is not supported

# SCREENSHOT OF MONITORING A MULTICOM 401 IN A PROFIBUS NETWORK

The screenshot shows the 'HW Konfig - [MA (Diagnose) ONLINE]' window. On the left, a component list for 'LUP1' includes:

- 1 PS 405 10A
- 3 PS 405 10A
- 5 CPU 416-2 DP
- 6 DP
- 7 MPV/DP
- 8 CP 443-1
- 9 DI32xDC 24V
- 10 DI16xDC 230V Rel
- 11 DI16xDC 230V Rel
- 12 ANK1.30x

The main area displays a network diagram with two DP-Master systems (MA DP-Mastersystem [1] and [2]) connected to various slave devices including EH 277, Befehls, Domest, IM 153, and DP-MODM.

Below the diagram is a table for 'Multicom 401':

Steckplatz	DP-Kennung	Bestellnummer / Bezeichnung	E-Adresse	A-Adresse	Kommentar
1	440	PPD Type 5	528_526	528_526	
2	74BY	-- PPD Type 5	528_527	528_528	

The screenshot shows the 'Var - Multicom401' window displaying a table of variable values for 'Multicom401 -- @24\_AufbereitungMAVCPU 416...':

Operand	Symbol	Anzeig	Statuswert	Steuerwert
1				
2	PEW 592	BIN	2#1000_0000_0110_0000	
3	PEW 594	BIN	2#0001_0000_0000_0000	
4	PEW 596	DEZ	234	
5	PEW 598	DEZ	234	
6	PEW 600	DEZ	234	
7	PEW 602	DEZ	23	
8	PEW 604	DEZ	5	
9	PEW 606	DEZ	2	
10	PEW 608	DEZ	378	
11	PEW 610	DEZ	100	
12				
13	PAW 528	HEX	0	VW#16#1030
14	PAW 530	HEX	0	VW#16#0300
15	PAW 532	HEX	0	VW#16#0000
16	PAW 534	HEX	0	VW#16#0000
17	PEW 534	DEZ	4210	
18				

The status bar at the bottom indicates '24\_Aufbereitung[MA]...[57-Programm]' and 'RUN' mode.

# CONNECTORS PINOUT

## PROFIBUS CONNECTOR

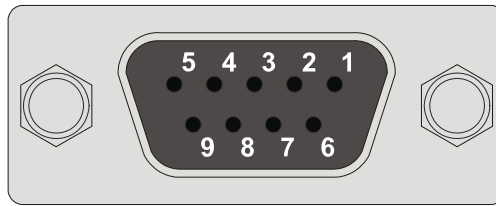

PIN #	DESCRIPTION
1	NC
2	NC
3	RXTX+
4	RTS
5	GND
6	+5V <sub>dc</sub>
7	NC
8	RXTX-
9	NC

## SERIAL 2

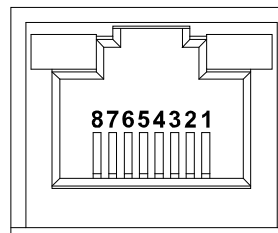

PIN #	DESCRIPTION
1	GND
2	GND
3	RXD
4	TXD
5	n.c.
6	n.c.
7	n.c.
8	n.c.

## DIAGNOSTIC LED

In the operational mode the meanings of LEDs are:

LED	Color	Description
Led RUN	Green	Regular working
	Blank	UPS communication error
Led ERROR	Yellow	Profibus cable disconnected or gateway not in data-exchange
	Blank	Regular Profibus connection

## TECHNICAL DATA TABLE

MULTICOM 401			
POWER SUPPLY <sup>(1)</sup>	Input voltage	[Vdc]	12
	Maximum input current	[mA]	350
ENVIRONMENT CONDITIONS	Operating temperature	[°C]	0 ÷ +40
	Storage temperature	[°C]	-5 ÷ +50
	Relative humidity (in operation)	[%]	80 (max)
	Relative humidity (in storage)	[%]	90 (max)
PHYSICAL CHARACTERISTICS	Dimensions H x L x D	[mm]	28 x 77 x 158
	Weight	[g]	250

<sup>(1)</sup> Polarity of the connector: 



